



BOSCH	U11002
	FIAT DOBLO/ STRADA
FC000C60004/005	REPARACIÓN UR0170/UR0171
53 DTS/10 EST / Ø10MM	

BOSCH	U11003
TIPO EV	FIAT DUCATO/ FORD F250
	PEUGEOT BOXER/ CITROEN JUMPER
0001223001/ 0001223013	REPARACIÓN UR0107/UR0128
40 DTS / 16 EST/Ø12MM	

BOSCH	U11010
TIPO DW	ZEN-12683
	ASTRA / BLAZER/ S10/ VECTRA/ ZAFIRA
37 DTS / 10 EST/ Ø12MM	

BOSCH	U11015
TIPO DW	ZEN-12685
	ESCORT / SEAT/ VW
37DTS Ø12MM	

BOSCH	U11019
TIPO DW	ZEN-12681
	VOLKSWAGEN GOL/
37 DTS 10E Ø12MM	

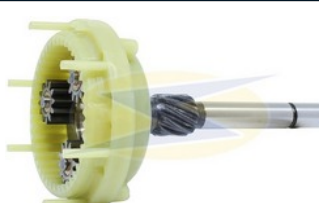
BOSCH	U11025
	FIORINO 1.7D/ IVECO
0.001.110.025	42 DTS 10E Ø12MM

BOSCH	U11029
	NISSAN MEXICO V-16
36 DTS / 10E/ Ø10/12MM	

BOSCH	U11037
TIPO DW	ZEN-12689
	TEMPRA 2.0/ PALIO 1.6
37 DTS/ 10E/ Ø12MM	

BOSCH	U11056
	MBB 180D / SSANGYONG MUSSO 2.9D
42 DTS /10E/ Ø12MM	

BOSCH	U11058
	ASTRA 2.0/VECTRA 2.0/ ZAFIRA 2.0
37 DTS /10E/ Ø12MM	



**IMPORTADORA
ISIS**

**Importación, Exportación
y Comercialización de Repuestos
de Vehículos**
Ignacio Carrera Pinto #1161, Rancagua.
Fono: 72-2-583570
ventas@importadoraisis.cl



BOSCH

TIPO DW

U11059

**CHRYSLER DAKOTA 2.5D/
MERCEDES BENZ C180**

37DTS/10E/ Ø10-10.9MM



BOSCH

U11067

ASTRA/BLAZER/S10/

42 DTS /10E/ Ø12MM



BOSCH

U11079

**FIAT DUCATO 2.3
PEUGEOT BOXER
CITROEN JUMPER**

37 DTS /10E/ Ø10-12MM



BOSCH

Ø14,5MM / 12MM 10E

U11090

**FORD F250/350
CUMMINS**

40 DTS /10E/ Ø12-14,2MM



BOSCH

U11099

**DUCATO 2.3/2.8
STRADA 1.9D /1.7TD
SPRINTER 312D/
NISSAN NAVARA**

38 DTS /10E/ Ø12MM



BOSCH

TIPO DW

U11104

**SILVERADO 4.1/ BRAVA
MAREA / CLIO 2.0/
LAGUNA 2.0**

37 DTS /10E/ Ø12MM



BOSCH

U11111

HILUX /SW4/ 2.5/2.8/3.0D

F000 AL0 111

EJE 94,7MM
37 DTS /10E/ Ø12MM



BOSCH

U11123

**VW/RENAULT/CITROEN/
OPEL/AUDI/**

EJE 92,5MM
36 DTS /10E/ Ø12MM



BOSCH

U11126

VW LT 2.5D/ LT 2.5 TD

EJE 81,1MM
38 DTS /16E/ Ø7,9-14,2MM



BOSCH

TIPO DW

U11128

ZEN-12690

**VW GOLF 1.8/FIAT
TEMPRA 2.0**

EJE 92,5MM
37 DTS /10E/ Ø10,9-12MM





**IMPORTADORA
ISIS**

**Importación, Exportación
y Comercialización de Repuestos
de Vehículos**
Ignacio Carrera Pinto #1161, Rancagua.
Fono: 72-2-583570
ventas@importadoraisis.cl



BOSCH

U11138

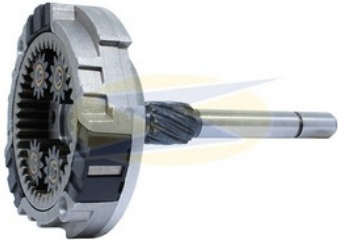

**MARCOPOLO VOLARE
SPRINTER /312**

**EJE 103,7MM
42 DTS /10E/ Ø12MM**

BOSCH

U11173



BOSCH EV

SCANIA

**EJE 91,2MM
41 DTS /14E/ Ø18MM**

BOSCH

U11218



**CITROEN JUMPER 2.8HDI
DUCATO 2.3/ BOXER
2.8 HDI**

**EJE 96,3MM
38 DTS /10E/ Ø12MM**

BOSCH

U11220



**HILUX D4D/ SW4/YARIS
COROLLA/ RAV4**

**EJE 94,7MM
37 DTS /10E/ Ø12MM**

BOSCH

U11358



**FIAT BRAVO/STRADA
MBB SPRINTER 515 Cdi**

**EJE 91,1MM
40 DTS /16E/ Ø8-14,2MM**

0001121440

BOSCH

U11367



**VW GOLF/ JETTA/
NEW BEETLE/TIGUAN
TOURAN**

**EJE 91,2MM
37 DTS /16E/ Ø8-10,9MM**

0001121402/ 0001121435

BOSCH

U11369

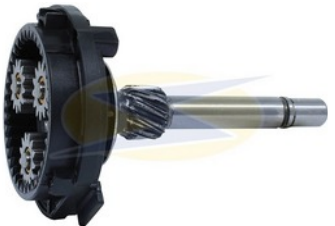

**MBB SPRINTER 311 Cdi
415/515 Cdi/ BMW 325**

**EJE 79,3MM
37 DTS /10E/ Ø10-10,9MM**

F000AL0901/ F000AL0903

BOSCH

U11408



**MBB SLK / SERIE C/
E200 1.8 / C200 2.0**

**EJE 86,5MM
37 DTS /10E/ Ø9,9-11,9MM**

0001147408 / 0001147409

BOSCH

U11477

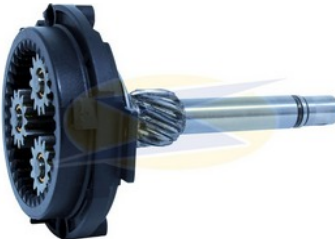

**RENAULT CLIO/DUSTER
LAGUNA 2.0/ SCENIC**

**EJE 79,4MM
36 DTS /10E/ Ø10-11MM**

0001107433/ 0001107438

BOSCH

U11493



**MBB SPRINTER/ VITO
KOMPRESSOR
FIAT STILO/ PUNTO
MAREA**

**EJE 79,2MM
37 DTS /16E/ Ø13,9-10MM**

0001107401/ 0001107402



**IMPORTADORA
ISIS**

**Importación, Exportación
y Comercialización de Repuestos
de Vehículos**
Ignacio Carrera Pinto #1161, Rancagua.
Fono: 72-2-583570
ventas@importadoraisis.cl



BOSCH

U11512



001115089

**MBB SPRINTER/ VITO
KOMPRESSOR
FIAT STILO/ PUNTO
MAREA
EJE 93,8MM
36 DTS /10E/ Ø12MM**

BOSCH

U11514

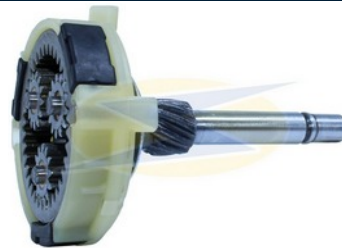

001107456

**COROLLA 1.8/2.0
CITROEN C1 1.0
PEUGEOT 107
BMW 116
EJE 79,4MM
36 DTS /10E/ Ø10MM**

BOSCH

U11588



0001124028 / 0001125626

**TOYOTA HILUX 2.8/3.0D
SW4 2.8D
EJE 91,2MM
36 DTS /16E/ Ø14,2/10,9MM**

BOSCH

U11590

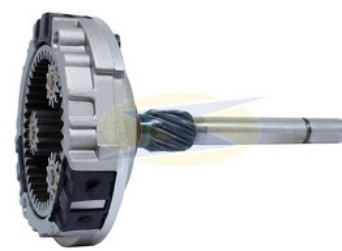

**FIAT DUCATO 2.5D/
MBB 310 SPRINTER
DODGE DAKOTA 2.5D
GM BLAZER 2.5D
EJE 103,9MM
42 DTS /10E/ Ø12MM**

BOSCH

U11625



F000AL2625

**FORD CARGO C
MBB SPRINTER 515 Cdi
EJE 106,1MM
37 DTS /10E/ Ø12MM**

BOSCH

U11663

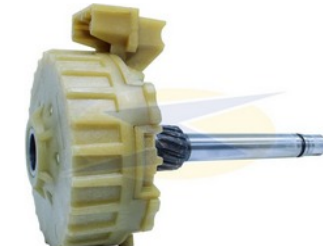

0001170663

**CHEVROLET TRACKER 1.0
EJE 95,3MM
37 DTS /16E/ Ø10MM**

BOSCH

U11727

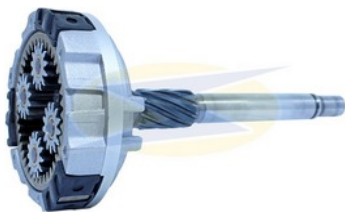

F002G20904

**FORD CARGO C1317/ 1319
1517/1519/1717/1719
2422/2423
EJE 136,1MM
40 DTS /10E/ Ø12-14,2MM**

BOSCH

U11779



F000AL0128

**FORD CARGO C814/815/
MBB / MWM/ VALMET
NEW HOLLAND
EJE 108,4MM
38 DTS /10E/ Ø12MM**

DELCO

C/RODAMIENTO

U14032

28MT



**CUMMINS 4BT/6BT/6BT
MBB 710/1418R/L1620/
OM364/OM366
EJE 172MM
31 DTS /12E/ Ø14MM**

DELCO

U14057



8000357/ 36100-2G200

**KIA SPORTAGE 2.0
HYUNDAI SANTA FE
SONATA/ TUCSON
EJE 73,3MM
42 DTS /8E/ Ø12MM**



DELCO

U14095

TIPO 38MT

FORD CARGO 1622/1630
2422/2622/4030
VW 17220/ 19320/ 31320
C/MOTOR 8.3L
EJE 97,4MM
48 DTS /12E/ Ø12,9MM

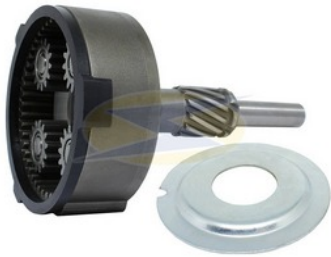

DELCO

U14150

ZEN-12720

ASTRA/ BLAZER/ S10/
VECTRA II

EJE 76,9MM
50 DTS /12E/ Ø12MM



DELCO

C/RODAMIENTO

U14357

MBB 712C/914C/915C/
1218L/1417/OM904 24V

EJE 175,4MM
31 DTS /12E/ Ø14MM



DELCO

TIPO PG260D

U14368

GM-CHEVROLET ASTRA/
BLAZER/ S10/ VECTRA II
16V

EJE 80,7MM
50 DTS /12E/ Ø12MM

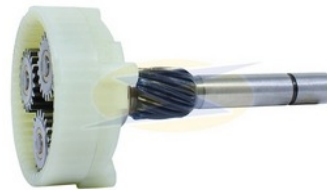

DELCO

U14410

TIPO 39MT

CUMMINS/ CASE
NAVISTAR/ CATERPILLAR
NEW HOLLAND

EJE 97,4MM
48 DTS /12E/ Ø13MM



8200032/ 8200291

DELCO

TIPO PG260B

U14525

CHEVROLET ONIX
PRISMA

EJE 71,5MM
50 DTS /8E/ Ø12MM

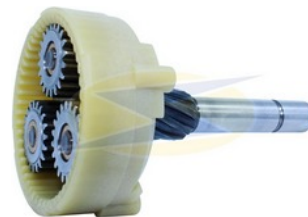

DELCO

U14534

UR0181/ UR0182

HYUNDAI HR 2.5/ H1 2.5
KIA BONGO K2500 2.5 TCI

EJE 80,2MM
48 DTS /12E/ Ø10-12MM



8000534/ 36100-4A150

DELCO

TIPO PG260D

U14711

CHEVROLET/ GM

EJE 73MM
43 DTS /8E/ Ø10,6MM

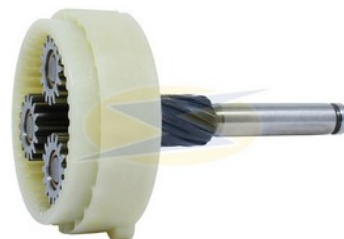

DELCO

U14811

TIPO 29MT

MBB /VW/ FORD/ VOLVO

IMPULSOR 6 ESTRIAS
EJE 79,2MM
44 DTS /12E/ Ø12MM



DELCO

U14812

TIPO 29MT

MBB /VW/ FORD/ VOLVO

IMPULSOR 7 ESTRIAS
EJE 79,2MM
44 DTS /14E/ Ø12MM





**IMPORTADORA
ISIS**

Importación, Exportación
y Comercialización de Repuestos
de Vehículos

Ignacio Carrera Pinto #1161, Rancagua.
Fono: 72-2-583670
ventas@importadoraisis.cl



DELCO

U14868



8000868 / 36100-4A160

UR0183

HYUNDAI HR 2.0/ H1 2.5/
PORTER/ KIA BONGO K2500

EJE 79,2MM
46 DTS /8E/ Ø11,9-10MM

DELCO

U14890

TIPO PG260G



BLAZER/S10
C/MOTOR VORTEC V6 4.3

EJE 80,4MM
43 DTS /12E/ Ø12MM

DELCO

U14910



PG260M / PMGR
CHEVROLET GM

EJE 93MM
48 DTS /12E/ Ø12MM

DELCO

U17210



JEEP WRANGLER
CHARGER/ DURANGO V6

EJE 72,2MM
41 DTS /10E/ Ø13,9-10MM

DENSO

U17011



428000-5011

HONDA ACCORD 2.0/
CIVIC 1.6/ CRV 2.0

REPARACIÓN UR0189/R0190
EJE 99,4MM
43 DTS /10E/ Ø11MM

DENSO

U17190

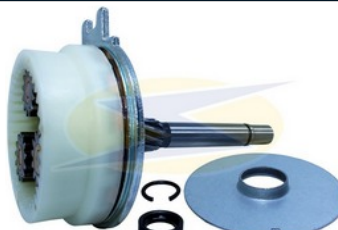

428000-8190 / 428000-5380

HONDA RIDGELINE 3.5/
HONDA PILOT 3.5/
HONDA NEW CIVIC

REPARACIÓN UR0169
EJE 84,7MM
37 DTS /10E/ Ø10,9-10MM

DENSO

U17330



428000-3330/ 428000-6980

DODGE RAM 2500 5.9/
RAM 2500 6.7/ RAM 3500

REPARACIÓN UR0199
EJE 163,4MM
39 DTS /12E/ Ø16,3-20MM

DENSO

U17400



428000-7400

JEEP GRAND CHEROKEE
CHRYSLER

REPARACIÓN UR0164
EJE 82,5MM
42 DTS /10E/ Ø10-11MM

DENSO

U17414



428000-0130 / 428000-3860

CATERPILLAR 320D
JOHN DEERE 370E/

REPARACIÓN UR0198
EJE 195MM
41 DTS /16E/ Ø16,9MM

DENSO

U17420



428000-8420

FORD F150/ F1000/F4000

REPARACIÓN UR0136
EJE 72,2MM
42 DTS /10E/ Ø10-11MM



DENSO

U17490



BMW 116i /118i/ 523 2.5i

**EJE 72,8MM
42 DTS /10E/ Ø10-11MM**

428000-4490

DENSO

U17640



**JEEP WRANGLER 3.8L
CHRYSLER**

**EJE 88,4MM
43 DTS /10E/ Ø11MM**

428000-6640

DENSO

U17902



TOYOTA RAV4 / AVENSIS

**REPARACIÓN UR0200
EJE 73,8MM
55 DTS /10E/ Ø10,9MM**

428000-5880 / 428000-0152

DENSO

U17950



**RANGE ROVER SPORT/
DISCOVERY 2.7/**

**REPARACIÓN UR0206/UR0207
EJE 75,4MM
37 DTS /10E/ Ø12MM**

428000-5950 / 428000-4880

ISKRA

U18446



JCB

**EJE 131,2MM
42 DTS /10E/ Ø14,2MM**

AZE4181/ AZE4186/ AZE4576

ISKRA

U18622



**CASE / M FERGUSON/
VALTRA/ J DEERE**

**EJE 131,4MM
38 DTS /14E/ Ø14,2MM**

16911622 / MSX522

ISKRA

U18623

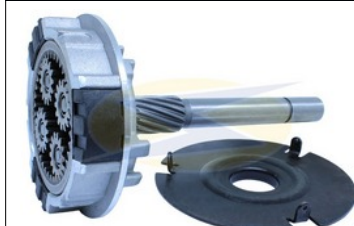

**BOBCAT/ JOHN DEERE/
IVECO/ NEW HOLLAND
HR100**

**EJE 120,90MM
38 DTS /14E/ Ø14,15MM**

AZE4139/ AZE4150/ AZE4199

ISKRA

U18628

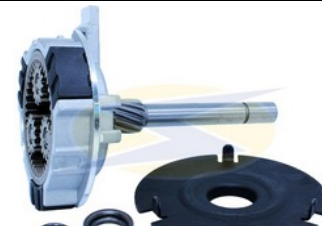

**VOLVO L20B/ L25B
ATLAS COPCO/ KHD**

**EJE 102,9MM
38 DTS /14E/ Ø12MM**

16911628

ISKRA

U18832



**JOHN DEERE/ ZETOR/
VALTRA/ M FERGUSON
NEW HOLLAND/ CASE**

**EJE 131,20MM / 24,90MM
42 DTS /10E/ Ø14,15MM**

AZF4508/ AZF4141/ AZF4577

ISKRA

U18944



HATZ 1B4005/ JCB

**REPARACIÓN UR0160
EJE 131,20MM / 24,90MM
42 DTS /10E/ Ø14,2MM**

11131995/ 11132230



**IMPORTADORA
ISIS**

**Importación, Exportación
y Comercialización de Repuestos
de Vehículos**
Ignacio Carrera Pinto #1161, Rancagua.
Fono: 72-2-583570
ventas@importadoraisis.cl



ISKRA

U18979



**NEW HOLLAND CX720/
CX740/ CX760/CX820/CX840**

**EJE 130,90MM / 24,70MM
42 DTS /10E/ Ø14,2MM**

11130941/ IS1120/ AZF4595

JHAEM

U14400



**KIA RIO / MORNING
CX740/ CX760/CX820/CX840**

**REPARACIÓN UR0188
EJE 72,7- 49,6MM
40 DTS /8E/ Ø9,9MM**

JM000A15001 / 36100-03400

JHEECO

U14104



JAC J3 1.4/ J5

**REPARACIÓN UR0204/0205
EJE 73MM
38 DTS /8E/ Ø9,9/11,9MM**

1043100GG01C

MOTORCRAFT

U13118



FORD FOCUS 1.6/2.0

**EJE 76,7MM
45 DTS /12E/ Ø11,9MM**

MOTORCRAFT

U13119

ZEN-12717

ESCORT/ FIESTA/ KA

**EJE 79,7MM
45 DTS /12E/ Ø12MM**

96BB11000AA

MOTORCRAFT

U13120



RANGER V6/ ECOSPORT

**EJE 89,5MM
37 DTS /12E/ Ø12MM**

F8TU11000 DD 9251-A1

MOTORCRAFT

U13121

**FORD RANGER
EXPLORER 4.0**

**EJE 81,2MM
37 DTS /12E/ Ø12MM**

F07UAA716A

MOTORCRAFT

U13122

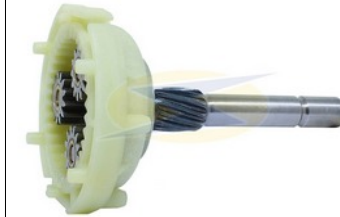

FORD F150/ F1000/F4000

**EJE 81,2MM 17,6MM
37 DTS /12E/ Ø12MM**

F2TUAA7C27A

MITSUBISHI

U15100

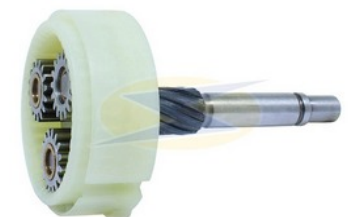

**MAZDA MPV/NISSAN
S10**

**EJE 79MM
42 DTS /8E/ Ø12-9,9MM**

MITSUBISHI

U15101

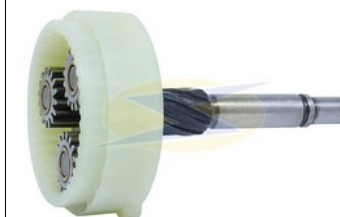

**HORQUILLA MITSUBISHI/
CLARK/FORKLIFT**

**EJE 76,8MM
43 DTS /8E/ Ø9,9MM**



MITSUBISHI

U15103



**MITSUBISHI L200 SPORT
GM S10**

**EJE 77,5MM
44 DTS /8E/ Ø9,9-13MM**

M002T87771

MITSUBISHI

U15104



**HORQUILLA HYSTER/
FORKLIFT/RENAULT**

**EJE 77,5MM
44 DTS /8E/ Ø9,9-13MM**

MITSUBISHI

U15105



4M40

**MONTERO 2.8TD
CANTER**

**EJE 62,1MM
44 DTS /10E/ Ø12MM**

M008T75071A

MITSUBISHI

U15106



**IVECO EUROSTAR
FORD L6000/
VW 13-180/15-180**

**EJE 83,4MM
44 DTS /12E/ Ø14MM**

M9T61671

MITSUBISHI

U15107



MB AXOR / ACTROS

**EJE 87,3MM
46 DTS /12E/ Ø14MM**

MITSUBISHI

U15108



**VW CONSTELLATION
MAN SERIES 7/8/10/12/15**

**EJE 75MM
44 DTS /10E/ Ø12MM**

MITSUBISHI

U15109

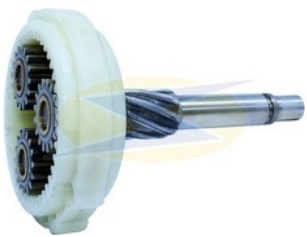

**LOGAN / SANDERO
NISSAN TIIDA**

**EJE 75,4MM
42 DTS /8E/ Ø9,9-12MM**

M000TD1371ZE

MITSUBISHI

U15113



UR0165/ UR0180

FORD RANGER 2.2/ 3.2

**EJE 87,3MM
43 DTS /8E/ Ø13-10MM**

M002T86071ZT/ AB39-11000-BA

PRESTOLITE

M100R

U12100

KO-1497

**AGRALE/ CUMMINS
VW OMNIBUS/ MBB**

**EJE 120,4MM
38 DTS /12E/ Ø15MM**

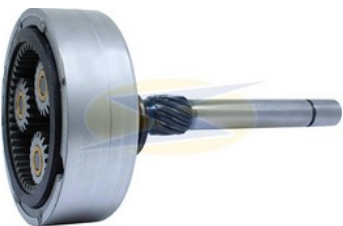

PRESTOLITE

M100R

U12101

KO-1561

JOHN DEERE

**EJE 81,7MM
48 DTS /12E/ Ø12MM**





PRESTOLITE

M93R

U12147

ZEN-12682

OMNIBUS VOLARE/
BLAZER/ S10/ MWM/
FORD CARGO/ VW
EJE 98,4mm
39 DTS /10E/ Ø12mm

PRESTOLITE

M93R

U12149

ZEN-12686

MB OMNIBUS /
CUMMINS SERIE B
FORD/ DIMEX
EJE 120,9mm
39 DTS /10E/ Ø12mm

PRESTOLITE

M93R

U12212

ZEN-12692

MERCEDES BENZ

EJE 120,1mm
39 DTS /10E/ Ø14mm

PRESTOLITE

M93R

U12219

ZEN 12687

VOLKSWAGEN

EJE 136,4mm
39 DTS /10E/ Ø12mm

PRESTOLITE

M93R

U12221

ZEN-12675

M FERGUSON
FORD F250

EJE 98,9mm
39 DTS /10E/ Ø14mm

PRESTOLITE

M93R

U12222

ZEN-12684

DEUTZ/ JOHN DEERE/
PERKINS /MWM/MAXION
MASSEY FERGUSON

EJE 120,1mm
39 DTS /10E/ Ø14mm

PRESTOLITE

35261260

U12225

UR0195/ UR0196

FORD RANGER 2.3/
FORD FOCUS 2.0/

EJE 87,8mm
38 DTS /9E/ Ø11,9mm

PRESTOLITE

M93R

U12343

ZEN-12688

VW / FORD
CUMMINS

EJE 126,7mm
39 DTS /10E/ Ø14mm

VALEO

36100-42350

U16101

HYUNDAI HR/ ACCENT 1.5/
KIA /SPRINTER

EJE 98,9mm
56 DTS /9E/ Ø10-12mm

VALEO

D6RA85/ D6RA185

U16102

CHEVROLET/RENAULT/
PEUGEOT/ CITROEN

EJE 82,6mm
37 DTS /10E/ Ø12mm



VALEO

U16103



**CHEVROLET/RENAULT/
PEUGEOT/ CITROEN**

**EJE 82,6mm
59 DTS /10E/ Ø12mm**

D6RA65/ D6RA165

VALEO

U16104



**SPRINTER/ CLIO/VITARA
PEUGEOT/ CITROEN
VW/ HYUNDAI HR**

**EJE 86,8mm
56 DTS /10E/ Ø10-12mm**

D7R11/ D7R15/DTR26

VALEO

U16105



**CLIO EXPRESS/ R19D
MEGANE/ LAGUNA
L200/ HR1**

**EJE 86,8mm
56 DTS /9E/ Ø10-12mm**

D7R11/ D7R15/DTR26

VALEO

U16106



RENAULT MASTER 2.2/2.5

**EJE 82,5mm
59 DTS /10E/**

D7G11/ 438170

VALEO

U16107



VW AMAROK 2.0 Tdi

**EJE 86,8mm
56 DTS /8E/ Ø9,9mm**

TS22ER12

VALEO

U16108

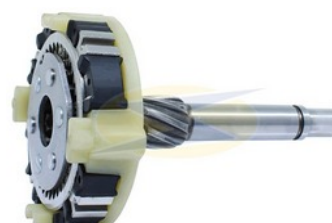

**KIA BONGO K2500
HYUNDAI H-1 2.5 CRDi
HR100**

**EJE 76,3mm
38 DTS /8E/ Ø10-12mm**

36100-4A200

VALEO

U16109



**MASTER III 2.3
S10 2.8/ TRAILBLAZER**

**EJE 80,6mm
56 DTS /8E/ Ø10mm**

TS22-32/ TS22E20

VALEO

U16110

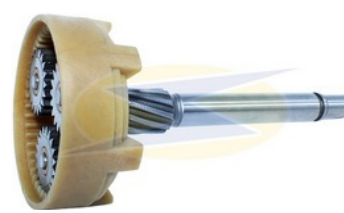

**AUDI A4 2.0/ QUATTRO 2.0
VW TOUAREG**

**EJE 104,6-14mm
47 DTS /10E/ Ø10mm**

TS14E42 / 458405

VALEO

U16111

GIRO IZQUIERDO

**VW GOL 1.6/ FOX 1.0
SPACE FOX / AUDI Q3**

**REPARACIÓN UR0191/R0192
EJE 78,3-43,8mm
46 DTS /8E/ Ø12mm**

TCS10R6 / 02M911021J

VALEO

U16112

GIRO IZQUIERDO

**VW GOL / SAVEIRO
POLO / FOX**

**REPARACIÓN UR0194
EJE 78,3-43,8mm
47 DTS /8E/ Ø12mm**

TCS10R7 / VA495107



**IMPORTADORA
ISIS**

**Importación, Exportación
y Comercialización de Repuestos
de Vehículos**
Ignacio Carrera Pinto #1161, Rancagua.
Fono: 72-2-523570
ventas@importadoraisis.cl



VALEO

U16113



**SUZUKI IGNIS / SWIFT 1.3
FIORINO 1.3/ STRADA 1.3
PEUGEOT 307/ 206/**

**REPARACIÓN UR0194
EJE 78,2-16,6mm
47 DTS /10E/ Ø12mm**

595660 / D6G3/ TS12E901

VALEO

U16114



**NISSAN QASHQAI 1.6
VOLVO S60/ S80/ S90**

**REPARACIÓN UR0178
EJE 82-18,5mm
56 DTS /8E/ Ø10-12mm**

31419530/ ESW20W11/

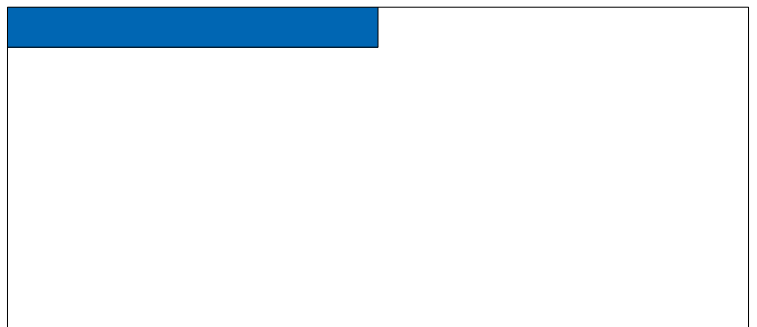
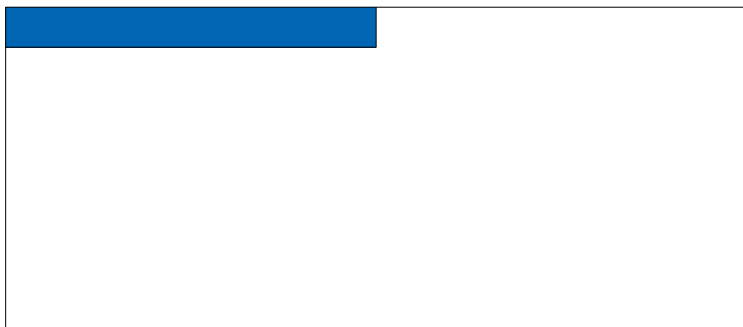
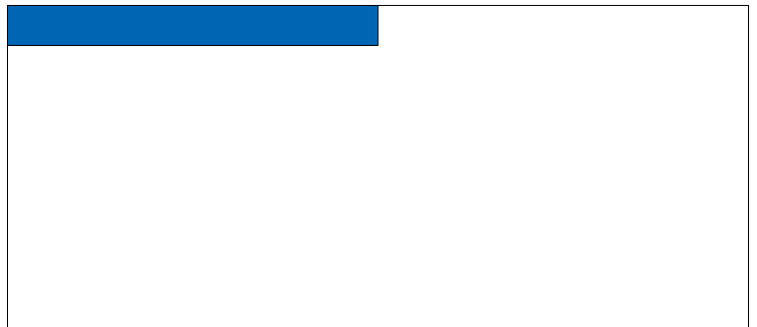
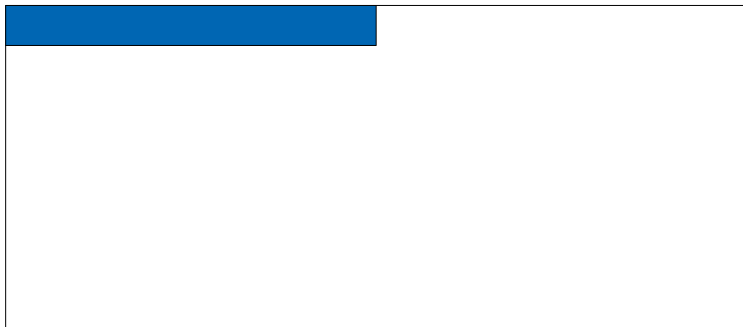
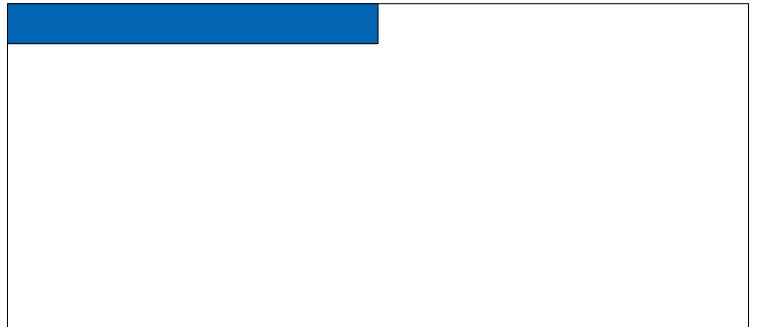
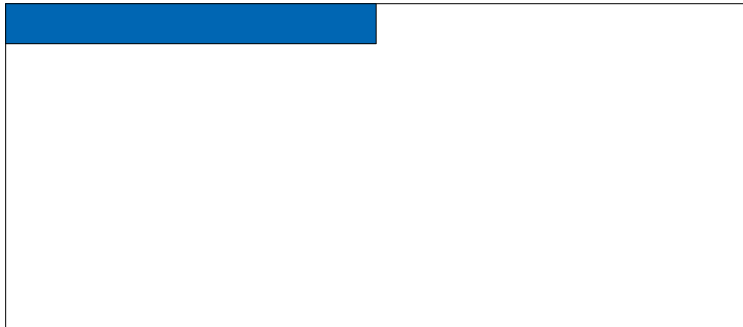
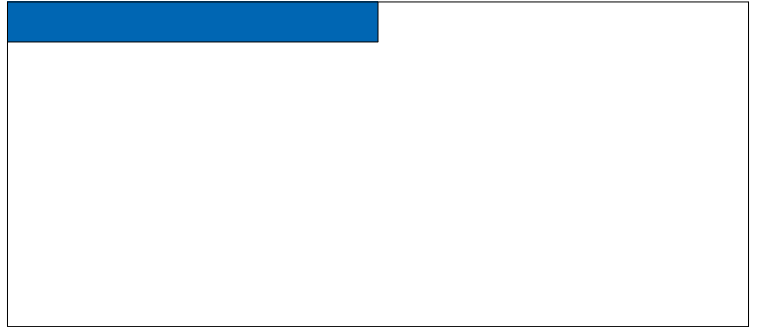



**IMPORTADORA
ISIS**

**Importación, Exportación
y Comercialización de Repuestos
de Vehículos**
Ignacio Carrera Pinto #1161, Rancagua.
Fono: 72-2-583570
ventas@importadoraisis.cl



BOSCH

**ZEN 12693
UNIFAP UR0056
37 DIENTES**



APLICACION: U11010/ U11015/ U11018/ U11128

BOSCH

**UR0057
37 DIENTES**



APLICACION: U11307

BOSCH

**UR0058
36 DIENTES**



APLICACION: U11161

BOSCH

**ZEN 12786
UNIFAP UR0060
36 DIENTES**



APLICACION: U11029

BOSCH

UR0062

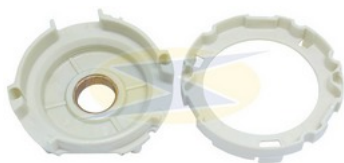

**MBB / BMW/ FORD
RENAULT**

APLICACION: U11104

BOSCH

UR0075



**JUMPER 2.8/
DUCATO 2.3/2.8
HILUX SW4/ GOLF 1.9**

**APLICACION:11220/1122
11143/ 11099/11111/11218**

BOSCH

**UR0076
38 DIENTES**



**DUCATO 2.3/2.8
STRADA 1.9D/ 1.7 TDS
MB 410 SPRINTER**

APLICACION: U11143/ U11099

BOSCH

**UR0077
38 DIENTES**



**JUMPER 2.8 HDI /
DUCATO 2.3/ BOXER 2.8**

APLICACION: U11218

BOSCH

UR0079



**MBB SPRINTER 515 Cdi
VW BORA/ POLO/ GOLF**

APLICACION: U11099/U11218

BOSCH

**ZEN 12694
UNIFAP UR0080
37 DIENTES**



APLICACION: U11010/ U11015/ U11018/U11037



**IMPORTADORA
ISIS**

**Importación, Exportación
y Comercialización de Repuestos
de Vehículos**
Ignacio Carrera Pinto #1161, Rancagua.
Fono: 72-2-583570
ventas@importadoraisis.cl



BOSCH

**UR0085
36 DIENTES**



APLICACION: U11029

BOSCH

**UR0086
37 DIENTES**



APLICACION: U11059

BOSCH

**UR0087
37 DIENTES**



(U11104)

APLICACION: U11104

BOSCH

**UR0094
37 DIENTES**



ASTRA 2.2/ VECTRA 2.2
ZAFIRA

APLICACION: U11058

BOSCH

**UR0105
42 DIENTES**



VW GOLF 1.9 TDS

APLICACION: U11122

BOSCH

UR0106



DUCATO 2.8 TD/
IVECO DAILY
PEUGEOT BOXER

APLICACION: U11003/ U11090

BOSCH

**UR0107
40 DIENTES**



DUCATO 2.8 TD/
IVECO DAILY
PEUGEOT BOXER

APLICACION: 11003/11090

BOSCH

**UR0108
38 DIENTES**



VW BORA /GOLF/JETTA
TRANSPORTER/
SKODA/ MBB

APLICACION: 11117/11118

BOSCH

UR0109



SSANGYONG MUSSO/
TRANSPORTER 2.4D
DODGE DAKOTA 2.5D

APLICACION: 11067/11073/11590/11056

BOSCH

**UR0110
42 DIENTES**



BLAZER 2.2/ DUCATO
SSANGYONG/JUMPER

APLICACION: 11067/11073/11590/11056



BOSCH

**UR0112
42 DIENTES**



**BLAZER 2.2/ DUCATO
SSANGYONG/JUMPER**

APLICACION: 11056

BOSCH

**UR0116
40 DIENTES**



FIAT BRAVO/STRADA

APLICACION: U11358

0001121440

BOSCH

**UR0117
40 DIENTES**



FIAT BRAVO/STRADA

APLICACION: U11358

0001121440

BOSCH

**UR0118
37 DIENTES**



**MBB SPRINTER 311
415/515 Cdi**

APLICACION: U11369

F000AL0901/ 0903

BOSCH

**UR0119
37 DIENTES**

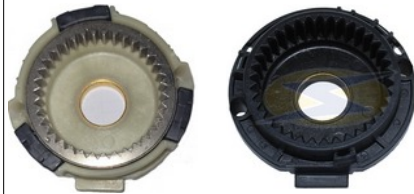

**MBB SPRINTER 311
415/515 Cdi
METALICA O NYLON
SON EQUIVALENTES**

APLICACION: U11369

F000AL0901/ 0903

BOSCH

**UR0120
37 DIENTES**



MBB SPRINTER 210

APLICACION: U11215

1006200125

BOSCH

**UR0121
42 DIENTES**



**FIAT IVECO LAND ROVER
MBB/ FORD /GM**

APLICACION: U11067/U11073/U11590

BOSCH

**UR0122
42 DIENTES**



FIORINO DIESEL 1.7

APLICACION: U11025

BOSCH

**UR0124
37 DIENTES**



**FIAT DUCATO/ BOXER/
JUMPER**

APLICACION: U11079/11116

0001115079

BOSCH

**UR0125
37 DIENTES**



**VW GOL 1.6D/SAVEIRO
TRANSPORTER**

APLICACION: U11079/11116/11190/11039

F010ALO103



**IMPORTADORA
ISIS**

**Importación, Exportación
y Comercialización de Repuestos
de Vehículos**

Ignacio Carrera Pinto #1161, Rancagua.
Fono: 72-2-583570
ventas@importadoraisis.cl



BOSCH

UR0126

36 DIENTES

mmB CLASSE A
HYUNDAI TUCSON



APLICACION: U11120

0001115008

BOSCH

UR0127

FORD ESCORT/ MONDEO



APLICACION: U11132

0001107016

BOSCH

UR0128

40 DIENTES

FIAT/ FORD/ IVECO



APLICACION: U111090/U11727/ U11003/ U11063

BOSCH

UR0129

42 DIENTES

FIORINO DIESEL 1.7



APLICACION: U11025

0001110025

BOSCH

UR0130

42 DIENTES

MBB MARCOPOLO



APLICACION: U11056

BOSCH

UR0131

37 DIENTES

FORD ESCORT 1.8/
MONDEO /FOCUS 1.8



APLICACION: U11132

1006200132

BOSCH

UR0139

40 DIENTES

FORD CARGO C1317/1319/
1517/1519/2622/2623



APLICACION: U11727

BOSCH

UR0140

38 DIENTES

MBB/ NEW HOLLAND
M FERGUSON/CASE/



APLICACION: U11779

BOSCH

UR0141

38 DIENTES

MBB/ NEW HOLLAND
M FERGUSON/CASE/



APLICACION: U11779

BOSCH

UR0144

40 DIENTES

VW BORA/ GOLF/ POLO
PASSAT/ NEW BEETLE



APLICACION: U11137



**IMPORTADORA
ISIS**

**Importación, Exportación
y Comercialización de Repuestos
de Vehículos**

Ignacio Carrera Pinto #1161, Rancagua.
Fono: 72-2-583570
ventas@importadoraisis.cl



BOSCH

**UR0148
36 DIENTES**

TOYOTA COROLLA 1.8/ 2.0
PEUGEOT 107/
RENAULT DUSTER 2.0



APLICACION: U11477 /U11508

0001107433 / 0001107441

BOSCH

**UR0149
36 DIENTES**

TOYOTA COROLLA 1.8/ 2.0
PEUGEOT 107/
RENAULT DUSTER 2.0



APLICACION: U11477 /U11508

0001107433 / 0001107441

BOSCH

**UR0152
37 DIENTES**

FIAT UNO/ MOBI/ ARGO



APLICACION: U11421

0001170421

BOSCH

**UR0159
37 DIENTES**

BMW



BOSCH

UR0161

COROLLA 1.8 /2.0
BMW 116/ 118/ 316 1.6i



APLICACION: U11514

0001107514 / 0001107426

BOSCH

**UR0168
42 DIENTES**

BMW 116/ 118/ 120/ 316 1.6i
X3 2.0i/ 525 2.5iX



APLICACION: U11327

0001107426/ 0001107526

BOSCH

**UR0170
53 DIENTES**

FIAT DOBLO/ STRADA
COTOLLA 2.0



APLICACION: U11002

F000C60004/F000C60300

BOSCH

**UR0171
53 DIENTES**

FIAT DOBLO/ STRADA
COTOLLA 2.0



APLICACION: U11002

F000C60004/F000C60300

BOSCH

**UR0172
37 DIENTES**

AUDI / SEAT/ SKODA
11663



APLICACION: U11367

0001121402/ 0001121435

BOSCH

**UR0173
42 DIENTES**

BMW 116/ 118/ 120/ 316 1.6i
X3 2.0i/ 525 2.5iX



APLICACION: U11327

0001107426/ 0001107526



**IMPORTADORA
ISIS**

**Importación, Exportación
y Comercialización de Repuestos
de Vehículos**
Ignacio Carrera Pinto #1161, Rancagua.
Fono: 72-2-583570
ventas@importadoraisis.cl



BOSCH



APLICACION: U11956

**UR0187
37 DIENTES**

MBB SPRINTER 213 2.2
SPRINTER 413/ 513 2.2
FIAT TORO/ DOBLO 1.6

0001108420/ F000AL0901

COMSTAR



**UR0157
42 DIENTES**
RENAULT DUSTER/
LOGAN / SANDERO
233004485R/233006904R

DELCO



APLICACION: U14057

**UR0132
42 DIENTES**

KIA SORENTO / SPORTAGE
HYUNDAI TUCSON

36100-2G000

DELCO



APLICACION: U14368

**UR0064
50 DIENTES**

ASTRA/ BLAZER/ S10
9000890/ 9000893

DELCO



APLICACION: U14910

**UR0065
48 DIENTES**

DELCO



APLICACION: U14890

**UR0071
43 DIENTES**

BLAZER/ S10/

DELCO



APLICACION: U14150

**ZEN 12721
UNIFAP UR0088
50 DIENTES**

DELCO



APLICACION: U14368

**UR0089
50 DIENTES**

DELCO



APLICACION: U14890

**UR0097
43 DIENTES**

BLAZER / S10

8000034/ 9000973

DELCO



**UR0177
50 DIENTES**

CHERY TIGGO 2.0

QDJ1266A



DELCO



**ZEN 12722
UNIFAP UR0063
50 DIENTES**

APLICACION: U14150

DELCO



**UR0182
42 DIENTES**

**HYUNDAI HR 2.5/ H1 2.5
KIA BONGO K2500**

APLICACION: U14534

8000534/ 36100-4A150

DELCO



**UR0183
46 DIENTES**

**HYUNDAI HR 2.0/ H1 2.5
KIA BONGO K2500**

APLICACION: U14868

8000868/ 36100-4A160

DENSO



**UR0136
42 DIENTES**

**MB C180/220
SPRINTER 213/313**

APLICACION: U17420

428000-8420

DENSO



**UR0151
41 DIENTES**

**FIAT UNO/ ARGO/
MOBI/ PALIO**

APLICACION: U17210

BC428000-9500/ 80023936

DENSO



**UR0163
55 DIENTES**

TOYOTA RAV4/ CAMRY

428000-5880

DENSO



**UR0164
42 DIENTES**

BMW

APLICACION: U17490

428000-4490

DENSO

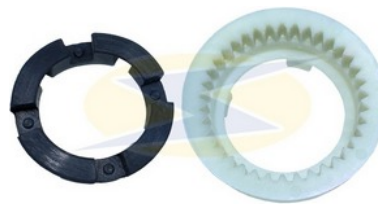

**UR0167
37 DIENTES**

**FIAT BRAVO 1.6
PALIO WEEKEND**

DENSO

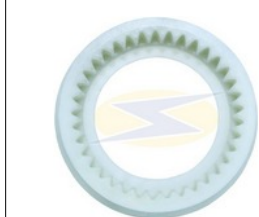

**UR0169
37 DIENTES**

**BMW X1/ 200i/ 225i
NEW CIVIC 1.8/2.0**

**Ø66,3mm
438000-0471/428000-8190**

DENSO



**UR0186
31 DIENTES**

**DODGE RAM 2500 5.9
RAM 3500/ 4000 5.9**

428000-1190



**IMPORTADORA
ISIS**

**Importación, Exportación
y Comercialización de Repuestos
de Vehículos**
Ignacio Carrera Pinto #1161, Rancagua.
Fono: 72-2-583570
ventas@importadoraisis.cl



DENSO



**UR0197
42 DIENTES**

SPRINTER 213/313/316
VITO 113/ 116
TOYOTA HILUX

428000-8420

DENSO



**UR0198
41 DIENTES**

CATERPILLAR 320D
JOHN DEERE 370E/

APLICACION: U17414

428000-0130

DENSO



**UR0206
37 DIENTES**

RANGE ROVER SPORT/
DISCOVERY 2.7/

428000-5950

APLICACION: U17950

DENSO

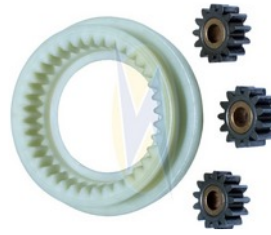

**UR0207
37 DIENTES**

RANGE ROVER SPORT/
DISCOVERY 2.7/

428000-5950

APLICACION: U17950

DENSO



**UR0199
39 DIENTES**

RAM 2500 5.9/ 6.7
RAM3500 5.9/
HINO 268 7.6

428000-3330/ 428000-9340

APLICACION: U17330

DENSO



**UR0200
55 DIENTES**

TOYOTA RAV4 /
AVENSIS 2.4/

428000-5880/ 22800-9901

APLICACION: U17190

DENSO



**UR0201
37 DIENTES**

BMW X1/ 216i/ 218 1.5

Ø65,9mm

438000-0417/ 438000-0470

APLICACION: U17471

DENSO



**UR0203
37 DIENTES**

HONDA ACCORD 3.5/
NEW CIVIC 1.8/ 2.0
PILOT / ODYSSEY 3.5

Ø66,3mm

428000-5380/ 428000-8190

APLICACION: U17190

HITACHI



**UR0175
40 DIENTES**

FIAT PALIO 1.0/1.3/1.4/
STRADA 1.3/1.4/
PUNTO 1.0/1.3/1.4/

S114-951A/ 51899848

ISKRA



**UR0146
42 DIENTES**

BOBCAT/ JOHN DEERE
CASE/ KOMATSU/ MBB
NEW HOLLAND/ VALMET

APLICACION: U18832

AZF4527/ AZF4129/



ISKRA



**UR0150
38 DIENTES**

JCB/ BOBCAT/ IVECO
M FERGUSSON/ ZETOR
VALTRA/ N HOLLAND

APLICACION: U18623

AZE4169/ AZE4261

ISKRA



**UR0156
42 DIENTES**

JCB

APLICACION: U18446

AZF4181/ AZF4224/ AZF4301

ISKRA



**UR0160
41 DIENTES**

HATZ 1B40 05/
JCB 4.4/ 4.8

APLICACION: U18944

11131995/11132230

ISKRA



**UR0184
38 DIENTES**

VOLVO/ ATLAS COPCO/
HAMM/ KRAMER/ KHD

APLICACION: U18628

11131948/11132027

JHAEM



**UR0185
40 DIENTES**

KIA RIO / HYUNDAI i10/
i20 1.2

JM000A15001/36100-03400

JHAEM



**UR0188
40 DIENTES**

KIA RIO / HYUNDAI i10/
i20 1.2

JM000A15001/36100-03400

JHEECO



**UR0204
38 DIENTES**

JAC J3 1.4/ J5

APLICACION: U14104

1043100GGG01C

JHEECO



**UR0205
38 DIENTES**

JAC J3 1.4/ J5

APLICACION: U14104

1043100GGG01C

MOTORCRAFT



**ZEN 12719
UNIFAP UR0059
45 DIENTES
(U13119)**

APLICACION: U13119

MOTORCRAFT



**UR0067
37 DIENTES**

APLICACION: U113120/ U13121/ U13122



**IMPORTADORA
ISIS**

**Importación, Exportación
y Comercialización de Repuestos
de Vehículos**

Ignacio Carrera Pinto #1161, Rancagua.
Fono: 72-2-583570
ventas@importadoraisis.cl



MOTORCRAFT

**ZEN 12718
UNIFAP UR0084
45 DIENTES**



APLICACION: U13119

MOTORCRAFT

UR0093

37 DIENTES



APLICACION: U13120/ U13121/ U13122

MOTORCRAFT

UR0212

45 DIENTES

FORD EDGE 3.5 V6/



APLICACION: U13117

MITSUBA

UR0166

41 DIENTES

**HONDA NEW FIT /
NEW CITY/ NEW CIVIC**



MITSUBISHI

UR0066

43 DIENTES



APLICACION: U14711

MITSUBISHI

UR0070

42 DIENTES



APLICACION: U15100

MITSUBISHI

UR0072

43 DIENTES



MITSUBISHI

UR0073

42 DIENTES



APLICACION: U15104

MITSUBISHI

UR0096

42 DIENTES

S10/ VOLARE/ NISSA



APLICACION: U15100

MITSUBISHI

UR0098

42 DIENTES

RENAULT/ HYSTER



APLICACION: U15104 / UR0103



**IMPORTADORA
ISIS**

**Importación, Exportación
y Comercialización de Repuestos
de Vehículos**
Ignacio Carrera Pinto #1161, Rancagua.
Fono: 72-2-583570
ventas@importadoraisis.cl



MITSUBISHI

UR0099

43 DIENTES

NISSAN/ SUBARU/
SUZUKI



MITSUBISHI

UR0100

43 DIENTES

APLICACION: U14711



MITSUBISHI

UR0101

44 DIENTES

JEEP WRANGLER/
GRAND CHEROKKE
CANTER 2.5D/ L200 2.5D
GRAN VITARA 1.6

APLICACION: U15103

M002T87771/ MD344183



MITSUBISHI

UR0102

44 DIENTES

MBB / L200/ GM S10

APLICACION: U15103



MITSUBISHI

UR0103

(U15101/U15103/U15104)



MITSUBISHI

UR0137

44 DIENTES

VW CONSTELLATION
VOLVO PENTA D4/D6
IVECO 180E/190S

APLICACION: U15108

M8T62671/ M008T55779



MITSUBISHI

UR0142

44 DIENTES

VW CONSTELLATION
MAN SEIRES 7/8/10/12/18

APLICACION: U15108



MITSUBISHI

UR0155

42 DIENTES

SANDERO / LOGAN
NISSAN TIIDA

APLICACION: U15109

M000TD1371ZE



MITSUBISHI

UR0154

41 DIENTES

FORD FUSION 3.0
COLORADO/ TRAVERSE 3.6

APLICACION: U15102

M000T16271ZC



MITSUBISHI

UR0165

43 DIENTES

FORD RANGER 2.2/ 3.2 Tdi

APLICACION: U15113

M002T86071ZT





**IMPORTADORA
ISIS**

**Importación, Exportación
y Comercialización de Repuestos
de Vehículos**
Ignacio Carrera Pinto #1161, Rancagua.
Fono: 72-2-583570
ventas@importadoraisis.cl



MITSUBISHI

UR0176

44 DIENTES



CRUZE / TRACKER/
ASTRA

12673600/ 695085118

MITSUBISHI

UR0180

43 DIENTES



FORD RANGER 2.2/ 3.2 Tdi

APLICACION: U15113

M002T86071ZT

MITSUBISHI

UR0210

43 DIENTES



MITSUBISHI ASX 1.8/
LANCER 1.8/
OUTLANDER 1.8/ 2.4

APLICACION: U15114

M000TC0271

MITSUBISHI

UR0216

41 DIENTES



FORD FUSION 3.0/
SUZUKI IGNIS 1.3/ 1.5/
CHEVROLET CAPTIVA 3.6

APLICACION: U15102

M000T16271ZC

MITSUBISHI

UR0217

42 DIENTES



RENAULT SANDERO/
LOGAN /
NISSAN VERSA

APLICACION: U15109

M000TD1371ZE

PRESTOLITE

ZEN 12695

UR0082

37 DIENTES



AGRALE / CUMMINS/
BLAZER

APLICACION U12147/ U12222/ U12343

PRESTOLITE

UR0095



U12147/U12149/U12212/
U12219/U12221/U12222/
U12223

PRESTOLITE

UR0104

38 DIENTES



FORD CUMMINS C 8.3
CUMMINS/ AGRALE

APLICACION: U12100

PRESTOLITE

UR0134



M93R

PRESTOLITE

UR0135



FORD CUMMINS C 8.3
CUMMINS/ AGRALE

APLICACION U12147/ U12149/ U12212/ U12222

APLICACION: U12100 / U12101



PRESTOLITE



**UR0147
39 DIENTES**

**MBB /FORD CARGO
CUMMINS**

APLICACION: U12412 / U12419/ U12421/U12449/

VALEO



**UR0068
37 DIENTES**

**RENAULT/PEUGEOT
CITROEN**

APLICACION U16102

VALEO



**UR0069
59 DIENTES**

**CORSA/ CLIO 1.8/
KANGOO**

APLICACION U16103

VALEO



**UR0113
59 DIENTES**

**RENAULT MASTER 2.5/
2.8 2006**

APLICACION U16106

D7G11

VALEO



**UR0114
56 DIENTES**

**HYUINDAI H1
ACCENT 1.5 CRDi
MBB SPRINTER**

APLICACION U16101

36100-42350

VALEO



**UR0115
56 DIENTES**

**VOLKSWAGEN AMAROK
2.0 Tdi**

APLICACION U16107

TS12ER15/ TS22ER12

VALEO



**UR0174
40 DIENTES**

FORD ECOSPORT 2.0 16V

FS14B2

VALEO



**UR0178
56 DIENTES**

**QASHQAI 1.6/ SCENIC 1.6
VOLVO S60/ S80/ S90**

APLICACION U16114

ESW20E26/ ESW20E3

VALEO



**UR0179
47 DIENTES**

**VW CROSSFOX/ SPACEFOX
GOLF/ POLO/SAVEIRO 1.6**

VALEO



**UR0191
46 DIENTES**

**VW GOL /FOX/ TOURAN
TRANSPORTER/ CROSS
SKODA**

APLICACION: U16111

TSC10R6/ 02M911021J



**IMPORTADORA
ISIS**

**Importación, Exportación
y Comercialización de Repuestos
de Vehículos**
Ignacio Carrera Pinto #1161, Rancagua.
Fono: 72-2-583570
ventas@importadoraisis.cl



VALEO



**UR0192
46 DIENTES**

VW GOL / FOX/ TOURAN
TRANSPORTER/ CROSS
SKODA

APLICACION: U16111

TSC10R6/ 02M911021J

VALEO



**UR0193
47 DIENTES**

VW GOL / SAVEIRO/POLO
GOLF

APL: U16113/U16112/U16110

TSC10R7/ VA495107

VALEO



**UR0194
47 DIENTES**

VW GOL / SAVEIRO/POLO
GOLF

APL: U16113/U16112/U16110

TSC10R7/ VA495107

VALEO



**UR0202
43 DIENTES**

BMW 320i

APLICACION: U16115

RSW22A12

VALEO

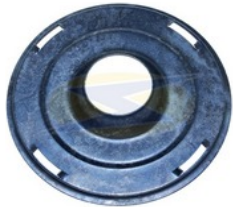

UR0208

KIA BONGO/ SORENTO
MBB SPRINTER/ VITO
MITSUBISHI/ NISSAN

APL:U16101/U16104/U16105/U16109

D7R12/ D7R28/ D8R29

VALEO



**UR0209
56 DIENTES**

SPRINTER/ CLIO/VITARA
PEUGEOT/ CITROEN
VW/ HYUNDAI HR

APLICACION: U16104

D7R11/ D7R20/ D7R27

